

flange wizard inc.®

"welders choice for quality" since 1981

Reg. No. 1,015,681

Vol 26 March 2025 Catalog



Miter Marker



Flange Aligner



Magnetic
Centering Heads

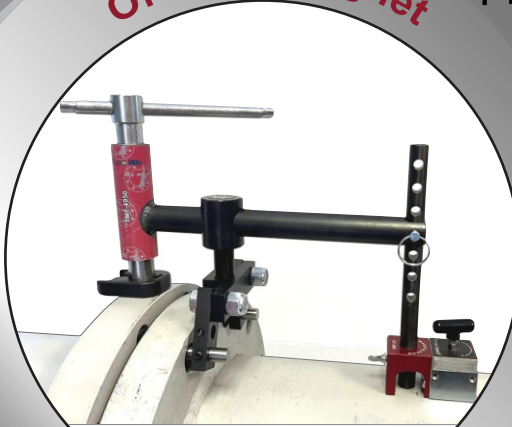

ON/OFF Magnet
The Manipulator Tool



Two Hole Pins



Pipe Wraps



Magnetic Digital
Centering Head



Winner of the *Excellence in Welding Awards*
in the small business category



Made in
the USA

Scan QR-Code
to Download
Spanish Catalog



FREE items

***Minimum distributor order is \$3,000 to receive FREE items.**

Fill in qty to build your own custom product display

QTY	PART #	DESCRIPTION	DIST. PRICE
25	CAT	COLOR CATALOGS (W/ HOLDER)	FREE *
1	9050	HEADER DISPLAY SIGN (25"L X 10"H)	FREE *
1	9052	SHELF FOR WRAPS	FREE *
1		COUNTER MAT	FREE *

CUSTOMIZE YOUR OWN DISPLAY:

SAMPLE SETUP

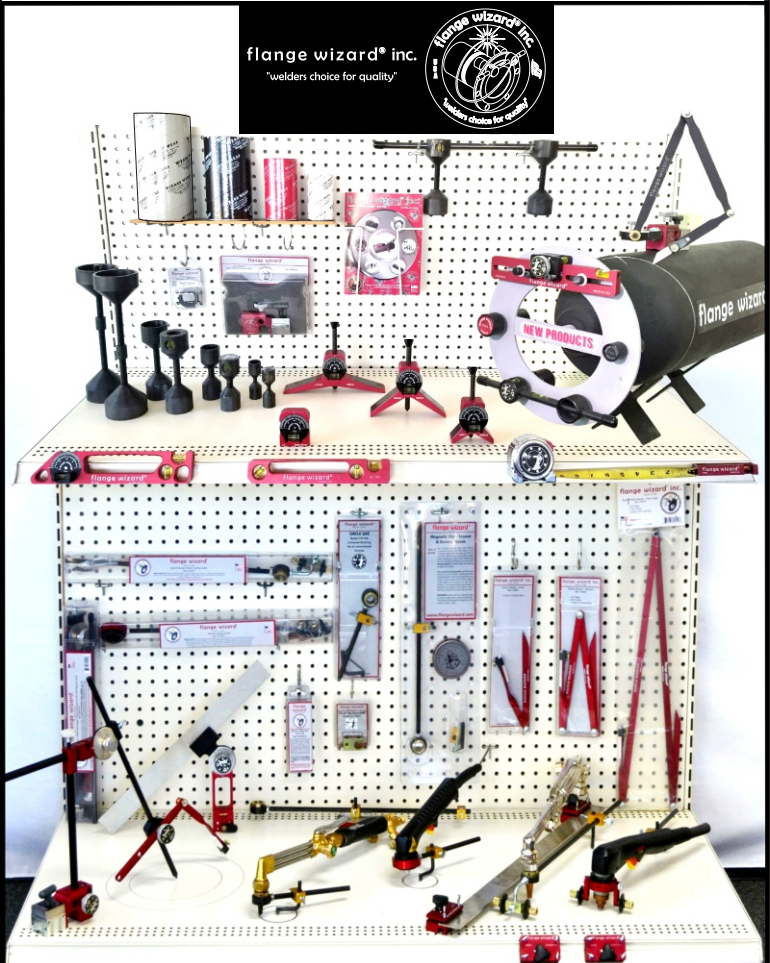

Scan QR-Code to watch Video

Screw on Flange with sticker with 3K Order (Customer applies to cylinder for showroom)



24219-CBG	CHARIOT BEVELING GUIDE
28439	MAGNETIC CIRCLE GUIDE
30061-1.	PLASMA WIZ w/BUSHING
38240-MAK	MAGNETIC FLANGE ALIGNER KIT
38240-T	THREADED ALIGNERS
38240-TL	THREADED ALIGNERS -LARGE
42050-MM	MAGNETIC PINS - MINI
42050-M	MAGNETIC PINS - MEDIUM
42050-ML	MAGNETIC PINS - LARGE
42050-TM	THREADED PINS-MINI
42050-T	THREADED PINS-MEDIUM
42050-TL	THREADED PINS-LARGE
42050-TXL	THREADED PINS-EXTRA LARGE
53025-M	CENTERING HEAD MAGNETIC-SMALL
53076-M	CENTERING HEAD MAGNETIC-MEDIUM
53077-D	DIGITAL MAGNETIC MEDIUM CENTERING HEAD
53085-M	CENTERING HEAD MAGNETIC-LARGE
53087-D	DIGITAL MAGNETIC LARGE CENTERING HEAD
72800	RADIUS MARKER-SMALL
72805	RADIUS MARKER-MEDIUM
72810	RADIUS MARKER-LARGE
89754	UNIVERSAL MAGNETIC TAPE HOLDER
ABG750	MULTI-USE ANGLE BURNING GUIDE
CW-300	CIRCLE WIZ
L-2	DEGREE LEVEL
MAA520	MULTI ANGLE & SQUARING ATTACHMENT
MHI515	MULTI-HOLE IMAGER w/CASE
MMC505	MITER MARKER/IMAGER COMBO CASE
MMC510	MASTER MARKER/IMAGER COMBO CASE
MML510	MASTER MARKER w/CASE
MMS505	MITER MARKER w/CASE
MSB202	BLOCKS, MAGNETIC OFF/ON (2)
MSG230	TORCH GUIDE w/MAGNETIC OFF/ON BLOCKS
PBG-601-1.	PLASMA BEVELING GUIDE w/BUSHING
61-1.	PLASMA BUSHINGS(CHOICE OF SIZES)
PP-200	POCKET PRO LEVEL
SBG301	STANDARD BURNING GUIDE
SL-100	STANDARD POCKET LEVEL
TMT-4950	THE MANIPULATOR TOOL
WW-16	WIZARD WRAP- SMALL
WW-17	WIZARD WRAP- MEDIUM
WW-17A	WIZARD WRAP- LARGE
WW-19	WIZARD WRAP- EXTRA LARGE
8905	PIPE MAGICIAN CASE
8905-M	PIPE MAGICIAN CASE - MAGNETIC
8910	WIZARD BURNING GUIDES CASE
8910-P-1.	WIZARD BURNING GUIDES CASE PLASMA
8915	LIL ' WIZ CASE
8915-P-1.	LIL ' WIZ CASE PLASMA
8920	DELUXE COMBO BURNING GUIDE

The FWI-Display is available from Flange Wizard to all distributors at a "ONE PRICE FOR ALL"
Check your wholesaler for availability

flange wizard® inc.

Counter Display

**Item
FWI-CD-C
(Distributors
only)**



Scan
QR-Code
to watch
Video



NEW COUNTER DISPLAY! From Flange Wizard®

This sturdy, compact flange (11" diameter) is a great way to show a number of tools at the counter or on an isle.

If they see the product it will sell!

Qty	FWI #	Description
2	38240-MAK	Magnetic Flange Aligner Kit
1	42050-T	Two Hole Pins Threaded Medium
2	42050-M	Two Hole Pins Magnetic Medium
1	42050-MM	Two Hole Pins Magnetic Mini
1	53076-M	Medium Centering Head w/Vial - MAGNETIC
1	53025-M	Small Centering Head w/Vial - MAGNETIC
2	PP-200	Pocket Pro Level
3	89754	Universal Magnetic Tape Holder
1	MSB202	Blocks, Magnetic OFF/ON

The **FWI-CD-C Counter Display** is available from Flange Wizard to all distributors at a "ONE PRICE FOR ALL"

Check your wholesaler for availability

Pipe Wrap Display

**Item #FWI-WD1
(Distributors only)**

Flange Wizard's distributors now can have all four of the most popular size wraps in a neat counter display.

The new **Pipe Wrap Display** will arrive completely assembled with product ready for your customers to purchase.

The **Pipe Wrap Display** includes the following Flange Wizard wraps:

- 12 **WW-16** Small Wraps
- 10 **WW-17** Medium Wraps
- 6 **WW-17A** Large Wraps
- 4 **WW-19** Ex-Large Wraps

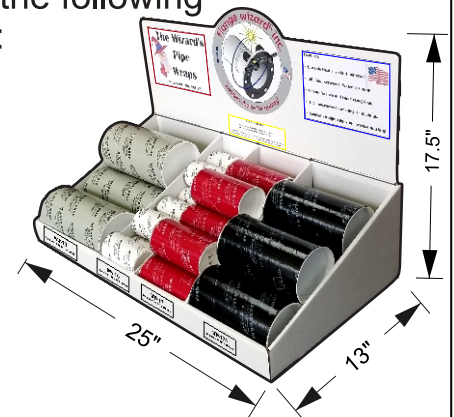

Scan QR-Code
to watch Video

The **FWI-WD1 Pipe Wrap Display** is available from Flange Wizard to all distributors at a "ONE PRICE FOR ALL"

Check your wholesaler for availability

The **Pipe Wrap Display** can be purchased alone with no product for \$25.00 (The empty container will ship unassembled.)

Pipe Flange Aligners

Item #'s

38240-T

38240-TL

Extensions are now available
for threaded models:

- 2-7/8" Stud P/N 0501
- 4-1/2" Stud P/N 0503
- Connecting Coupling P/N 0503-EX

CARE OF TOOL: Spray with WD40 or any light oil to protect from rust.



Scan QR-Code
to watch instructional Video

#38240T* – This model has threaded pins for flanges to 30" - 150 lbs. Fits flanges with holes up to 1-7/16" diameter x 2-1/2" thick. 1/2-13 double lead studs - 8" center to center. Aligner bar is 10" long.

#38240TL* – This is our largest model. Fits flanges with holes up to 1-15/16" in diameter x 4" thick. 1/2-13 double lead studs - 15" center to center. Aligner bar is 18" long.

All models of the Pipe Aligner will two-hole (make 2 holes of the flange horizontally level with the ground) and vertically level the flange in ONE easy step.

All models are made of steel and now come with 360° vials the just "snap" in and out for easy replacement.

The Pipe Flange Aligner saves valuable fit-up time; in most cases it cuts fit-up time in half and eliminates the frustration of balancing a level on the pins.

* Double-lead threaded studs are hardened for durability and designed for quick release

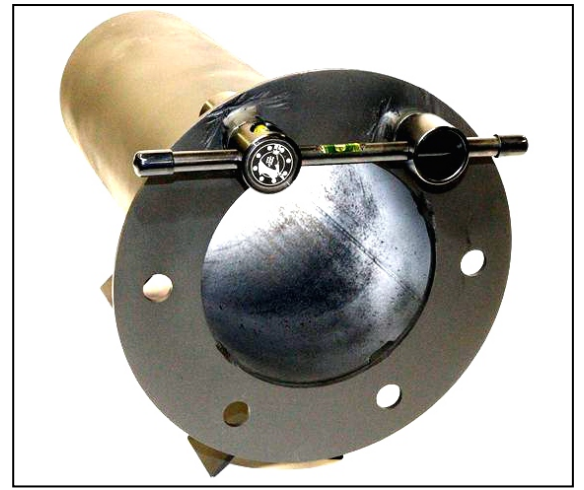
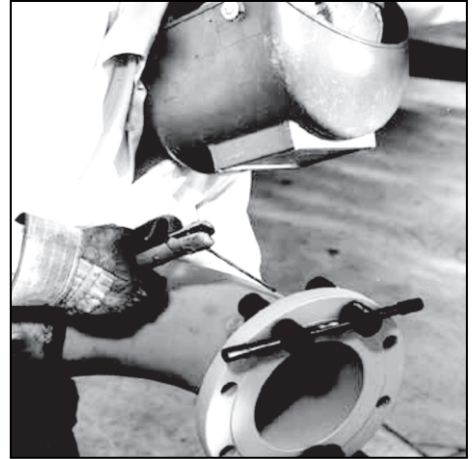

Two Hole Pins

Item #'s

42050-TM

42050-T

42050-TL

42050-TXL

Extensions are now available
for threaded models:

- 2-7/8" Stud P/N 0501
- 4-1/2" Stud P/N 0503
- Connecting Coupling P/N 0503-EX

CARE OF TOOL: Spray with WD40 or any light oil to protect from rust.



42050-TM—This model has pins that are threaded and fits 5/16" to 63/64" flange holes x 1" thick.

42050T* – This model has pins that are threaded and fits 1/2" to 1-7/16" flange holes x 2-1/2" thick.

42050TL* – This large set is threaded and fits 1/2" to 1-15/16" flange holes x 4" thick. NOTE: Above models have one pin with a bubble for easier vertical leveling and now come with 360° vials that just "snap" in and out for easy replacement.

#42050-TXL* - The extra large set is threaded and designed to be light weight for easier handling. They fit 5/8" to 3" flange holes. A set of 4-1/2" studs and connecting couplings are included to accommodate thicker flanges up to 9" thick.

* Double-lead threaded studs are hardened for durability and designed for quick release

Scan QR-Code to watch instructional Video



Magnetic Two hole Pins

Item

42050-MM

42050-M

42050-ML

Washer 

Magnet 

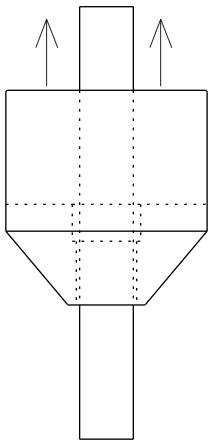

Note: Magnet can be removed for cleaning debris.

Extension
P/N 42050-EX



Scan QR-Code to watch instructional Video

The NEW Magnetic Two Hole Pins from flange wizard® are:

- FASTER AND HAVE NO THREADS TO DAMAGE OR NUTS THAT NEED TO BE SCREWED ON.

* The **Magnetic Mini Pins** (#42050-MM) will Self-align on holes from 5/16" to 7/8" diameter and will work on flanges from 7/16" to 7/8" thick.

* The **Magnetic Standard Pins** (#42050-M) will self-align on holes from 1/2" to 1-7/16" diameter and will work on flanges from 5/8" to 1-3/8" thick.

* The **Magnetic Large Pins** (#42050-ML) will self-align on holes from 3/4" to 1-15/16" diameter and will work on flanges from 1-1/2" to 2-3/4" thick.

*Some thicker flanges may require **Extensions**.
(See Chart on page 4)

Just place in flange holes and the NUTS and PINS bond together immediately with fastest magnetic speed possible. This brings the latest and fastest technology available to market for aligning flanges and base plates on pipe and stanchions of all kinds.

Refer to Chart on next page for flange thickness and hole sizes.

CARE OF TOOL: Spray with WD40 or any light oil to protect from rust.



WARNING: Always keep NUTS and PINS together to keep debris from getting inside the magnet housing.

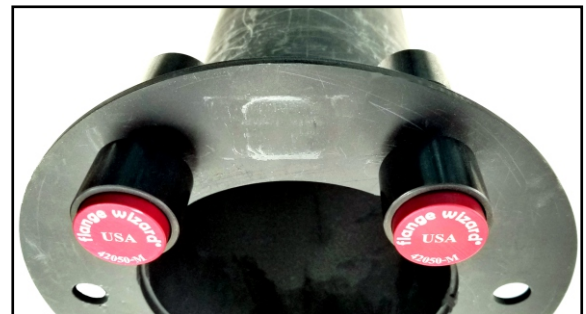

Extensions available to reach up to 3-1/2" thick flanges (P/N 42050-ML only)

flange wizard® inc.

Class 150 Flanges			Class 300 Flanges			Class 600 Flanges		
Pipe Size (Inches)	Thickness	Diameter of Bolt Holes	Pipe Size (Inches)	Thickness	Diameter of Bolt Holes	Pipe Size (Inches)	Thickness	Diameter of Bolt Holes
* 1/2	0.44 (7/16)	.62 (5/8)	* 1/2	0.56 (9/16)	.62 (5/8)	* 1/2	0.56 (9/16)	.62 (5/8)
* 3/4	0.50 (1/2)	.62 (5/8)	* 3/4	0.62 (5/8)	.75 (3/4)	* 3/4	0.62 (5/8)	.75 (3/4)
* 1	0.56 (9/16)	.62 (5/8)	* ☒ 1	0.69 (11/16)	.75 (3/4)	* 1	0.69 (11/16)	.75 (3/4)
* 1-1/4	0.62 (5/8)	.62 (5/8)	* ☒ 1-1/4	0.75 (3/4)	.75 (3/4)	* 1-1/4	0.81 (13/16)	.75 (3/4)
* ☒ 1-1/2	0.68 (11/16)	.62 (5/8)	* ☒ 1-1/2	0.81 (13/16)	.88 (7/8)	* ☒ 1-1/2	0.88 (7/8)	.88 (7/8)
* ☒ 2	0.75 (3/4)	.75 (3/4)	* ☒ 2	0.88 (7/8)	.75 (3/4)	☒ 2	1.00	.75 (3/4)
* ☒ 2-1/2	0.88 (7/8)	.75 (3/4)	☒ 2-1/2	1.00	.88 (7/8)	☒ 2-1/2	1.12 (1-1/8)	.88 (7/8)
* ☒ 3	0.94 (15/16)	.75 (3/4)	☒ 3	1.12 (1-1/8)	.88 (7/8)	☒ 3	1.25 (1-1/4)	.88 (7/8)
* ☒ 3-1/2	0.94 (15/16)	.75 (3/4)	☒ 3-1/2	1.19 (1-3/16)	.88 (7/8)	☒ 3-1/2	1.38 (1-3/8)	1.00
* ☒ 4	0.94 (15/16)	.75 (3/4)	☒ 4	1.25 (1-1/4)	.88 (7/8)	† ☒ 4	1.50 (1-1/2)	1.00
* ☒ 5	0.94 (15/16)	.88 (7/8)	☒ 5	1.38 (1-3/8)	.88 (7/8)	† 5	1.75 (1-3/4)	1.12 (1-1/8)
* ☒ 6	1.00	.88 (7/8)	☒ 6	1.44 (1-7/16)	.88 (7/8)	† 6	1.88 (1-7/8)	1.12 (1-1/8)
☒ 8	1.12 (1-1/8)	.88 (7/8)	† 8	1.62 (1-5/8)	1.00	† 8	2.19 (2-3/16)	1.25 (1-1/4)
☒ 10	1.19 (1-3/16)	1.00	† 10	1.88 (1-7/8)	1.12 (1-1/8)	† 10	2.50 (2-1/2)	1.38 (1-3/8)
☒ 12	1.25 (1-1/4)	1.00	† 12	2.00	1.25 (1-1/4)	● 12	2.62 (2-5/8)	1.38 (1-3/8)
☒ 14	1.38 (1-3/8)	1.12 (1-1/8)	† 14	2.12 (2-1/8)	1.25 (1-1/4)	● 14	2.75 (2-3/4)	1.50 (1-1/2)
☒ 16	1.44 (1-7/16)	1.12 (1-1/8)	† 16	2.25 (2-1/4)	1.38 (1-3/8)	● 16	3.00	1.62 (1-5/8)
† 18	1.56 (1-9/16)	1.25 (1-1/4)	† 18	2.38 (2-3/8)	1.38 (1-3/8)	● 18	3.25 (3-1/4)	1.75 (1-3/4)
† 20	1.69 (1-11/16)	1.25 (1-1/4)	† 20	2.50 (2-1/2)	1.38 (1-3/8)	● 20	3.50 (3-1/2)	1.75 (1-3/4)
† 24	1.88 (1-7/8)	1.38 (1-3/8)	† 24	2.75 (2-3/4)	1.62 (1-5/8)	* 42050-MM (Mini) ☒ 42050-M (Standard) † 42050-ML (Large) ● 42050-ML W/ Extension		
● 26	2.69 (2-11/16)	1.38 (1-3/8)	● 26	3.44 (3-7/16)	1.38 (1-3/8)			
● 28	2.81 (2-13/16)	1.38 (1-3/8)	● 28	3.44 (3-7/16)	1.38 (1-3/8)			
● 30	2.94 (2-15/16)	1.38 (1-3/8)	● 30	3.63 (3-5/8)	1.50 (1-1/2)			

Magnetic Pipe Flange Aligner Kit

Item #

38240-MAK



Scan QR-Code to watch instructional Video

Keep magnet block in "OFF" position when not in use.

Warning:
Excessive heat can damage the magnets. Keep magnet block away from sensitive electronic devices.

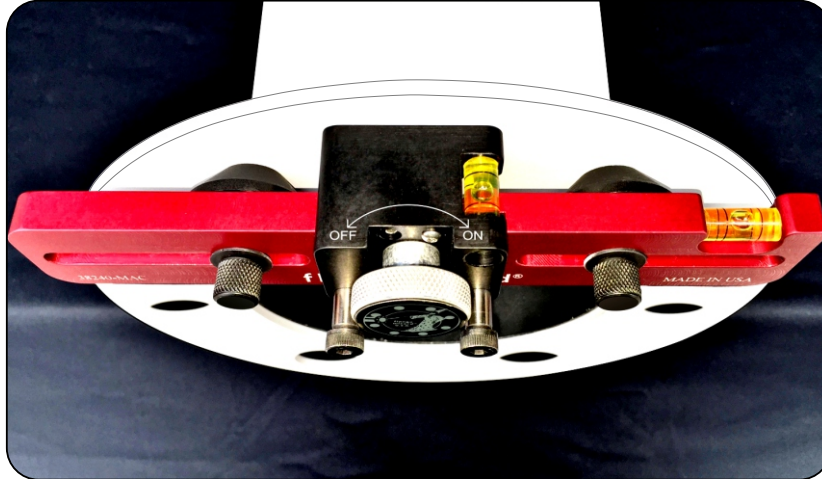

OFF/ON Magnetic Flange Aligner Kit

The pipe flange aligner with no threads and no nuts to lose. Flange Thickness is not longer a problem. Our Magnetic Flange Aligner Kit #38240-MAK will fit flange holes from 1/2" dia. up to 1-15/16" dia. and aligns both horizontally and vertically exclusively off the steel face of the flange.

It can go up to a 9-1/2" center to center hole spread.

The new technology of the OFF/ON 90 lb. magnet makes this tool the fastest and easiest flange aligner to use in the industry. The Centering Cones (SMALL set for 1/2" to 1-7/16" holes and LARGE set for 1/2" to 1-15/16" holes).

This ALIGNER comes in a compact case that will protect the tool from damage and keep it together in one place ready to use.

The new ON/OFF magnet allows for stronger holding power and easy removal of debris.

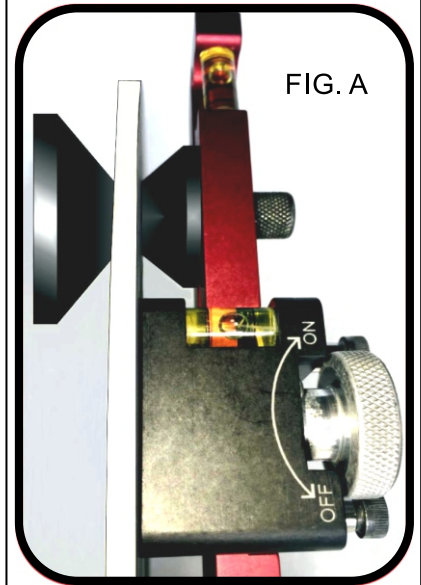

The extra Set of Cones can also be used as nuts when working with non-magnetic materials. (FIG. A)

The Manipulator Tool

Item #

TMT-4950



Scan QR-Code to watch instructional Video

Keep magnet block in "OFF" position when not in use.

Warning:
Excessive heat can damage the magnets. Keep magnet block away from sensitive electronic devices.

THE MANIPULATOR TOOL

- Helps with bolt-hole alignment or gasket repair.
- Piston puts out 4950 lbs of pressure.
- No bearings or hydraulics to mess with.

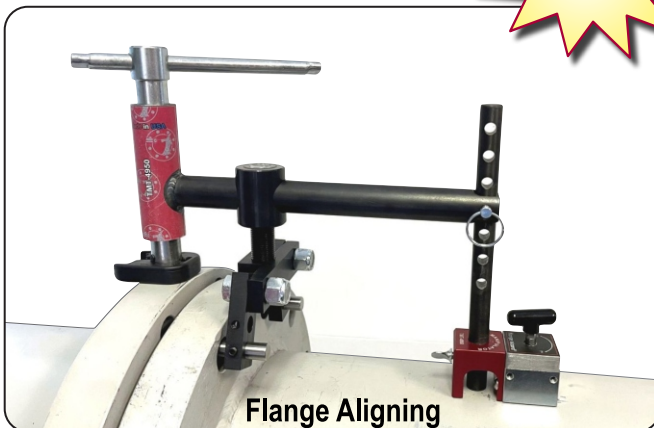
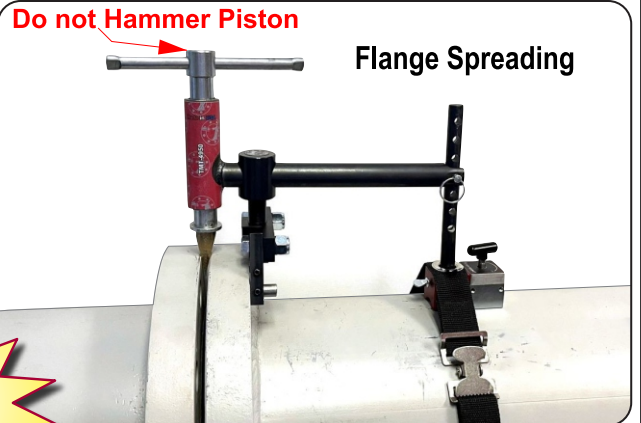

- Aluminum Bronze non-sparking Wedge to assist with spreading flanges.
- 150 lbs of holding power Magnetic Base to assist with setup.

The MANIPULATOR comes in a compact case that will protect the tool from damage and keep it together in one place ready to use.

MAGNETIC Small Centering Head

Item #
53025-M

Warning: Excessive heat can damage the magnets. Keep magnet block away from sensitive electronic devices.



The **Small Centering Head Tool** has a one-piece MAGNETIC "Y" shaped body like our other models, only smaller. The addition of the magnets in the legs will free up users' hands for a safer and more accurate layout mark. This tool is designed for the person who works with smaller diameter pipe. Fire protection contractors, fence and gate builders, live stock pens and corrals are a few of the many uses. It is machined from quality aluminum and anodized for lasting protection.

The dial is in 2-½° increments with spring tension for smooth operation.

Use it to establish and mark a centerline at any angle around the circumference on a pipe or tank. Use it as a **protractor level** on various alignment jobs.

[Scan QR-Code to watch instructional Video](#)



1" to 16" pipe hands free

MAGNETIC Medium Centering Head

Item #
53076-M

Warning: Excessive heat can damage the magnets. Keep magnet block away from sensitive electronic devices.



The **Medium Centering Head Tool**, with its one-piece "Y" shaped body is now **MAGNETIC**. This will free up users hands for safer and more accurate layout marks. Tool is designed to establish and mark a centerline at any angle around the circumference (inside or outside) of a pipe or tank. Use it as a **protractor level**, or remove and use the hardened center punch for other marking jobs. The vial is easy to repair.

The dial is in 2-½° increments with spring tension for smooth operation.

This tool is a must for the welder or fitter's toolbox.

[Scan QR-Code to watch instructional Video](#)



3" to 36" pipe hands free

MAGNETIC Large Centering Head

Item #
53085-M

Warning: Excessive heat can damage the magnets. Keep magnet block away from sensitive electronic devices.



The **Large Centering Head Tool** has a one-piece MAGNETIC "Y" shaped body like our other models, only wider and larger.

The wide-spread "Y" shape body has two strong magnets in each leg for maximum holding power and hands free layout.

The dial is in 2-½° increments with spring tension for smooth operation.

Use it to establish and mark a centerline at any angle around the circumference on a pipe or tank.

Use it as a protractor level on various alignment jobs.

[Scan QR-Code to watch instructional Video](#)

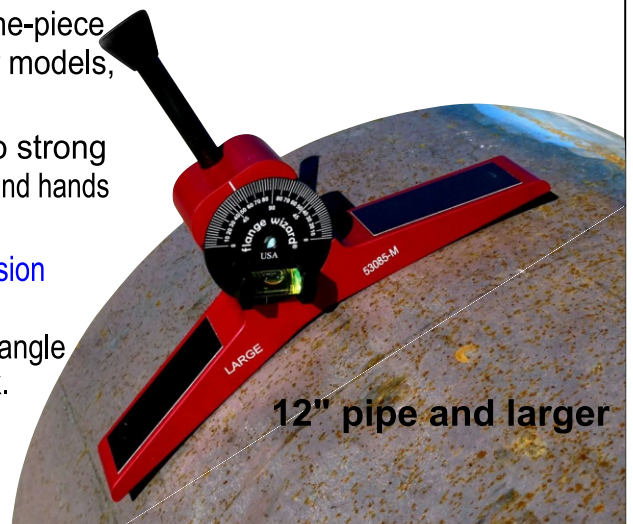

12" pipe and larger

flange wizard® inc.

Digital MAGNETIC Medium Centering Head

Item #
53077-D



Scan QR-Code
to watch
instructional Video

The New **53077-D Digital Magnetic Centering Head** (for pipe 3" and larger) is designed to establish and mark a center-line at any angle around the circumference (inside and out) on a pipe or tank. The wide-spread "Y" shape body has two strong magnets in each leg allowing hands free layout for up to 24" pipe.

Accuracy: +/- 0.2 of a degree
Battery: AAA X 2 (included)
Comes in a compact case

Warning: Excessive heat can damage the magnets.
Keep magnet block away from sensitive electronic devices.

The **Digital Centering Head** comes in a compact Carrying case #8901 that will protect the tool from damage and keep it together in one place ready to use.



Digital MAGNETIC Large Centering Head

Item #
53087-D



Scan QR-Code
to watch
instructional Video

The New **53087-D Digital Large Magnetic Centering Head** (for pipes 12" and larger) is designed to establish and mark a center-line at any angle around the circumference (inside and out) on a pipe or tank. The wide-spread "Y" shape body has two strong magnets in each leg for maximum holding power and hands free layout.

Accuracy: +/- 0.2 of a degree
Battery: AAA X 2 (included)
Comes in a compact case

Warning: Excessive heat can damage the magnets.
Keep magnet block away from sensitive electronic devices.



The **Digital Centering Head** comes in a compact Carrying case #8901 that will protect the tool from damage and keep it together in one place ready to use.

Miter Marker (in carrying case)

Item #
MMS505

Short Video



Scan QR-Codes to watch instructional Videos

Detailed Video



- Redesigned pipe marker has the latest **ON/OFF** magnet technology.
- Main body has a leveling vial built-in and a strong 150lb. ON/OFF magnet that works like a third hand.
 - Marks saddles and angles on pipe and structural steel.
 - Marking Arm has its own leveling system and a shaft that rotates 360° and telescopes to eliminate uneven surface problems.
 - Will layout pipe and structural beams from 1-1/2" to 18".
 - The new ON/OFF magnet allows for stronger holding power and easy removal of debris.
 - Structural Adaptor is included.

Structural Adaptor aligns tool base exactly parallel to edge of structural steel beams and channel iron.

* A Spring Buckle Strap #5010 is available to hold base tight on **non-magnetic** work materials.

Large Master Marker Arm item #MLA510 and Multi-Hole Imager-Tower item #MHA515 are available to work in conjunction with The Main Magnetic Body item #MMB500.

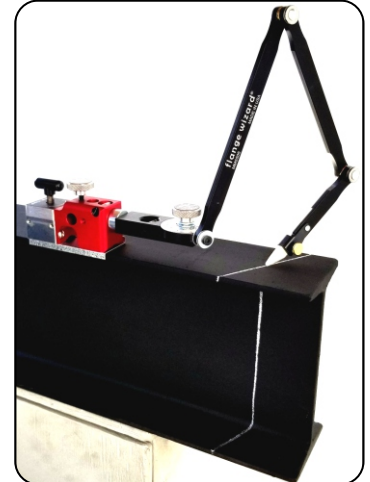
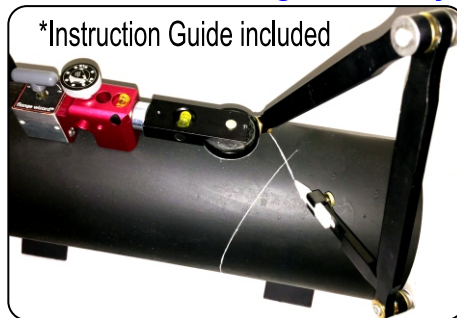

(Carrying Case # 8901)



Warning: Excessive heat can damage the magnets. Keep magnet block away from sensitive electronic devices. Keep magnet in "OFF" position when not in use.

Master Marker (in carrying case)

Item #
MML510

Short Video



Scan QR-Codes to watch instructional Videos

Detailed Video



- Redesigned pipe marker has the latest **ON/OFF** magnet technology.
- All same features as Item #MMS505 except larger arm will layout pipe and structural beams from 8" to 48".

Small Miter Marker Arm item #MSA505 and Multi-Hole Imager-Tower item #MHA515 are available to work in conjunction with The Main Magnetic Body item #MMB500.

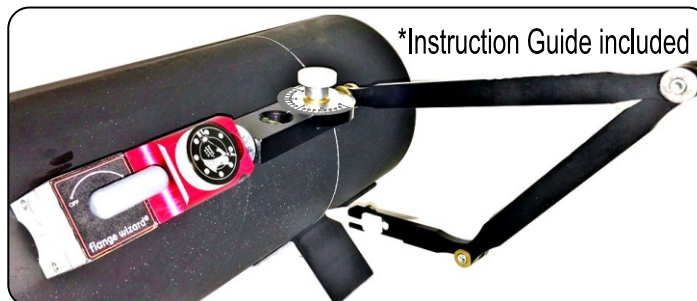

(Carrying Case # 8900)



Warning: Excessive heat can damage the magnets. Keep magnet block away from sensitive electronic devices. Keep magnet in "OFF" position when not in use.

flange wizard® inc.

Multi-Hole Imager (in carrying case)

Item #
MHI515

Marks 3/4" to 20" holes in plate with vertical shaft at 90°.

Marks 3/4" to 18" saddle holes in pipe with vertical shaft at 90°.

Large Marking Arm available for bigger diameters.
26" dia. on pipe
40" dia. on flat
Part # 1118-L

A **Spring Buckle Strap** is available to hold base tight on non-magnetic work materials.
Part # 5010



Short Video

Scan QR-Codes to watch instructional Videos



Detailed Video

The **Multi-Hole Imager** is one of Flange Wizard®'s finest layout tools. Has a strong **150Lb.** "ON/OFF" magnet which makes positioning on a round, flat, or irregular surface easy. A leveling vial is built in the main body and the marking arm to assist in leveling the tool as required.

The **Multi-Hole Imager** will layout round or elongated holes (**ellipses**) on flat material or pipe to match laterals at compound angles or at 90°.

A **protractor**, with adjustable shaft and sliding marking arm, fits in the main arm of the **Imager** allowing for layout of elliptical holes in header pipe for matching compound pipe laterals coming in to the header. It will layout matching holes in pipe for 90° saddle branches. The **Imager** is great for round holes in plate or elongated holes when coming in at an angle.

Large Master Marker Arm item #MLA510 and **Small Miter Marker Arm** item #MSA505 are available to work in conjunction with The Main Magnetic Body item #MMB500.

Warning: Excessive heat can damage the magnet. Keep magnet block away from sensitive electronic devices. Keep magnet block in "OFF" position when not in use.

*Instruction Guide included

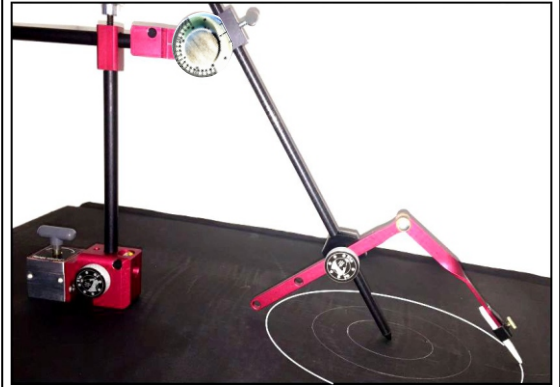

The **Multi-Hole Imager** comes in a compact case (#8900) for protection between jobs.



Multi Angle & Squaring Attachment

Angles



Item #MAA520 Works with our Miter or Master Marker Tool.

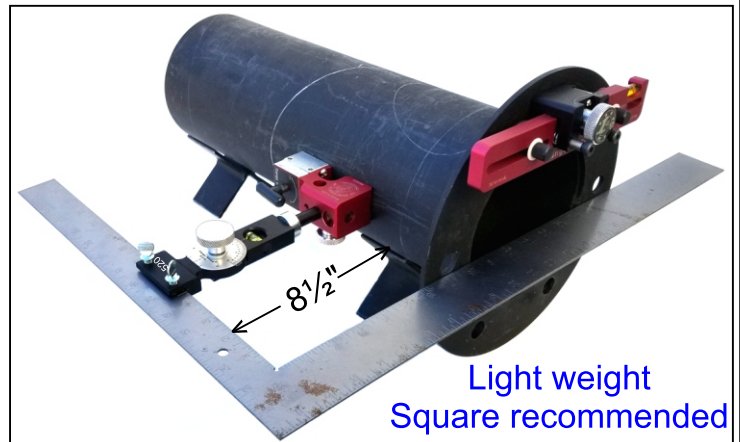

Light weight Square recommended

Squaring up the face of a Flange

flange wizard® inc.

Pocket Pro Level

**Item #
PP-200**

*A must
for the Solar industry!

Warning: Excessive heat
can damage the magnets.
Keep magnet away from
sensitive electronic devices.

GREAT DESIGN - One of the finest levels available in the welding industry. Designed to give years of quality service. Extra strong magnets hold it firmly to any steel surface. There are two (2) stationery vials placed at 90° angles of each other and can be read from any surface of the level. If vials are damaged, just remove them and replace with a new one (**VIAL REPAIR KIT #5102** includes 2 vials and a tube of sealant).

The dial is in 2-½° increments with spring tension for smooth operation.

Tool is machined from aluminum and anodized for a protective finish. Size is 2.00" wide x 10" long.



Standard Pocket Level

**Item #
SL-100**

Warning: Excessive heat
can damage the magnets.
Keep magnet away from
sensitive electronic devices.

This 9.0' long x 1.5' wide **magnetic** level has three-position leveling that can be viewed clearly from almost any angle. The **STANDARD POCKET LEVEL** is machined from aircraft quality aluminum and anodized for lasting beauty and protection. It is manufactured with the same high quality as our **POCKET PRO LEVEL (PP-200)** but designed for the tradesman who does not need the protractor degree dial. Like all of our other quality leveling tools, the **STANDARD POCKET LEVEL** can be repaired in the field using our vial repair kit (#5201).

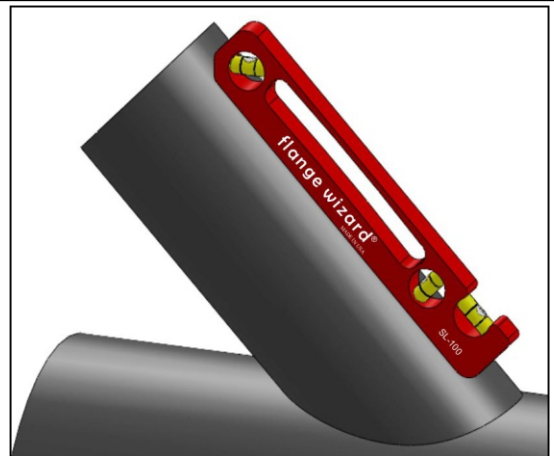

Level at 45° angle

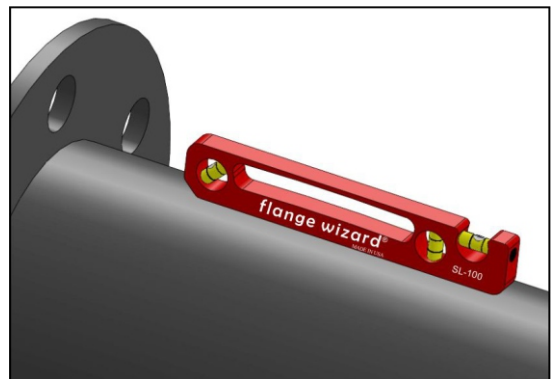

Level with vial at horizontal

flange wizard® inc.

Pocket Degree Level

**Item #
L-2**

*Ship builders love me!

Warning: Excessive heat can damage the magnets. Keep magnet away from sensitive electronic devices.

This pocket size, combination degree level makes it easy to establish angles and mark for butt-ins, set tanks, layout keyways and measure decline or slope. It is great for rod frames and setting drive lines and is also used in the auto industry. This compact tool is 2.00" wide x 2-1/2" long x 5/8" thick and has a degree dial marked in 2-1/2° increments and numbered every 10°. It has a 25 lb. magnet in the base for easy hands off use and can even hold the end of a tape measure for solo use. This is a great level for getting angles on hard to reach pipe or structural steel details. Refinery workers find it handy when getting angles on spools many feet off the ground.



Universal Magnetic Tape Holder

**Item #
89754**

Warning: Excessive heat can damage the magnets. Keep magnet away from sensitive electronic devices.

Designed with no removable parts and works with most industrial measuring tapes. It is a great little magnetic pocket level and a third hand when doing those difficult measuring jobs while working alone. The holder secures the end of your tape while laying out close tolerance measurements from the middle of your material. Tool is machined from aluminum and anodized for a protective finish. A strong 25 pound pull magnet set in epoxy secures the tape holder to your work. At one end of the tool is a small rare earth magnet to hold your measuring tape in place while laying out difficult jobs. Tape holder is 4" long x 5/8" square.



flange wizard® inc.

Vial Repair Kit

**Item #
5102**

Make your **flange wizard®** tools like new again with this repair kit.

One kit fits all. For quick on the job repairs for any of our tools that have leveling vials. Kit includes two (2) vials and one (1) tube of sealant.



Radius Markers (three sizes)

Item #'s

**72800 Small
11" span = 22"
circumference**

**72805 Medium
25" span = 50"
circumference**

**72810 X-Large
50" span = 100"
circumference**

The Wizard **Radius Markers** are precision tools made of rust proof aluminum and anodized for lasting protection. Three (3) sizes to choose from to mark your smallest circles to the large ones, up to 100" in diameter. The arms are precisely aligned with spring tension joints to guarantee accuracy and rigidity for years of service. Holder accommodates flat or round soapstone and pencils. Small and Medium models fold to pocket size. The extra large model can be adjusted tight in the center to eliminate any movement while marking large radius's or circles.

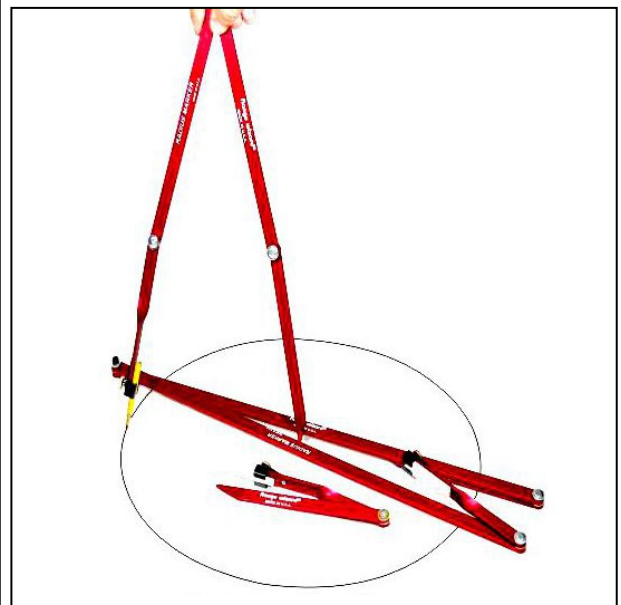
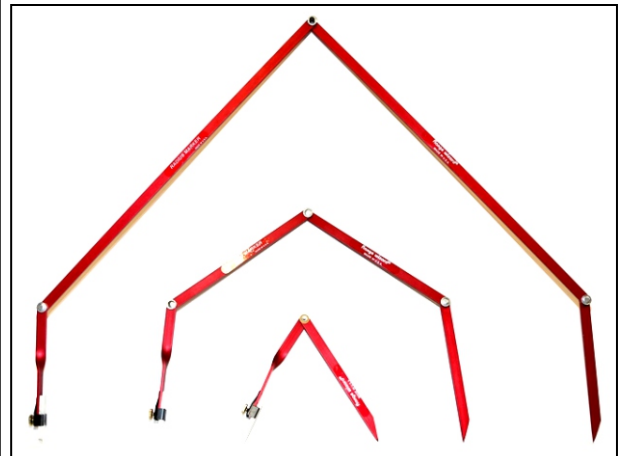

flange wizard® inc.

Multi-Purpose “Chariot Beveling Burning Guide”

Item #
24219-CBG

Available Accessory:
Extension Hex Bar
15-1/2”L #3311-EX

Flange Wizard's new burning guide is designed to not only cut straight, irregular shapes and circles, but also bevel them at the same time.

The new improved design makes height adjustment and setting the head at the proper angle for beveling a simple job for the beginner as well as the journeyman.

*** Universal bushing fits all conventional torches.**



Fig. C

The wheels can be adjusted for straight, irregular shapes, or circle cuts (Fig. A) and (Fig. B).

The new design allows you to use the third wheel (Fig. C), (Fig. D) and (Fig. E) in conjunction with our **Magnetic Torch Guide model #MSG230** for precision burning or beveling edges of plate, beams, channels, etc.

The head of the new guide will now lock in place for straight 90° or bevel cutting (Fig. F) at 22.5, 37.5 & 45 degrees.

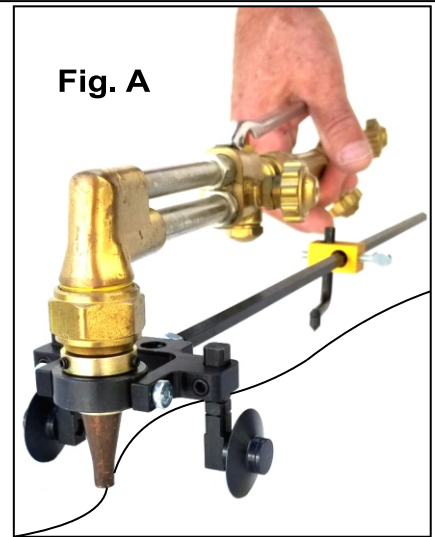

Fig. A

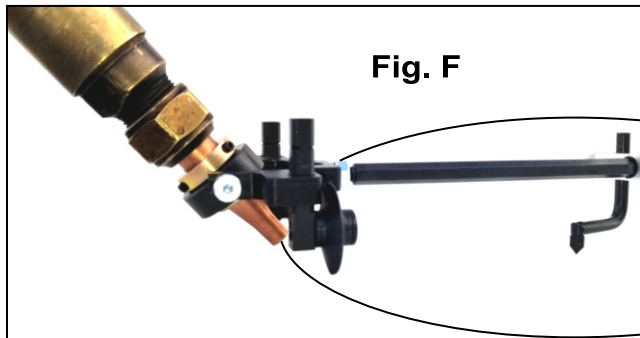

Fig. F

Cut 7" to 34" Dia. circles when beveling inside (Fig. F)

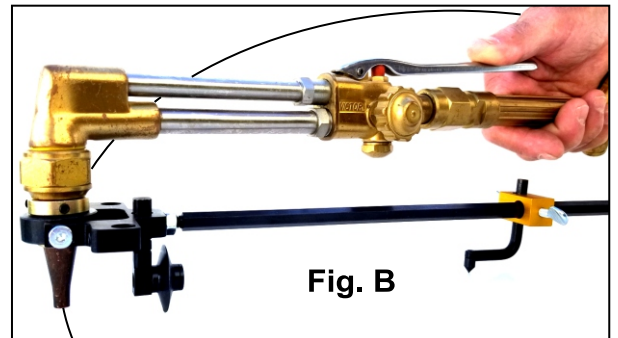

Fig. B

Cut 2" to 36" Dia. circles with regular set up (Fig. B).

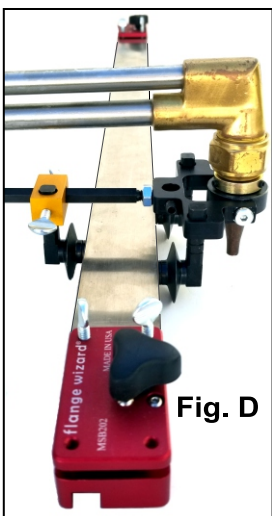
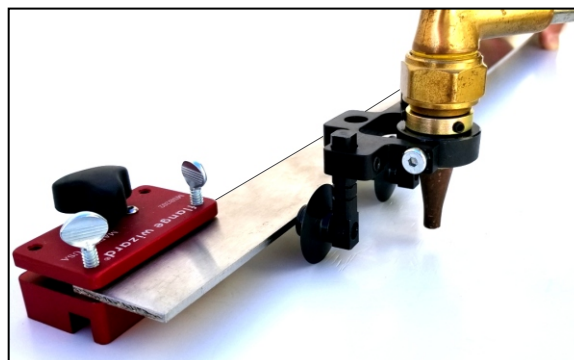

Fig. D

Scan QR-Codes to watch instructional Videos

Short Video



Detailed Video



Cut 7" to 37" Dia. circles when beveling outside.

CARE OF TOOL: Spray with WD40 or any light oil to protect from rust.

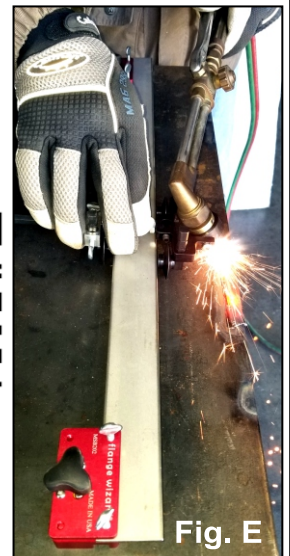

Fig. E

Standard Burning Guide

Item# SBG301

Conventional torch users can now start cutting corners with flange wizard®'s new **STANDARD BURNING GUIDE**.

This burning guide can reach into corners and tight places where other guides cannot go! Your torch tip can actually get right into a corner and have a single wheel stand-off to keep the tip at a proper distance from the work surface (Pic A).

The wheel can be rotated to be used with a straight edge guide (Pic B).

This cutting guide is great for demolition that requires getting into corners and tight work spaces. It also cuts holes from 5/8" to 24" diameter. Designed with a universal bushing, it fits any conventional torch tip (Pic C).

CARE OF TOOL: Spray with WD40 or any light oil to protect from rust.

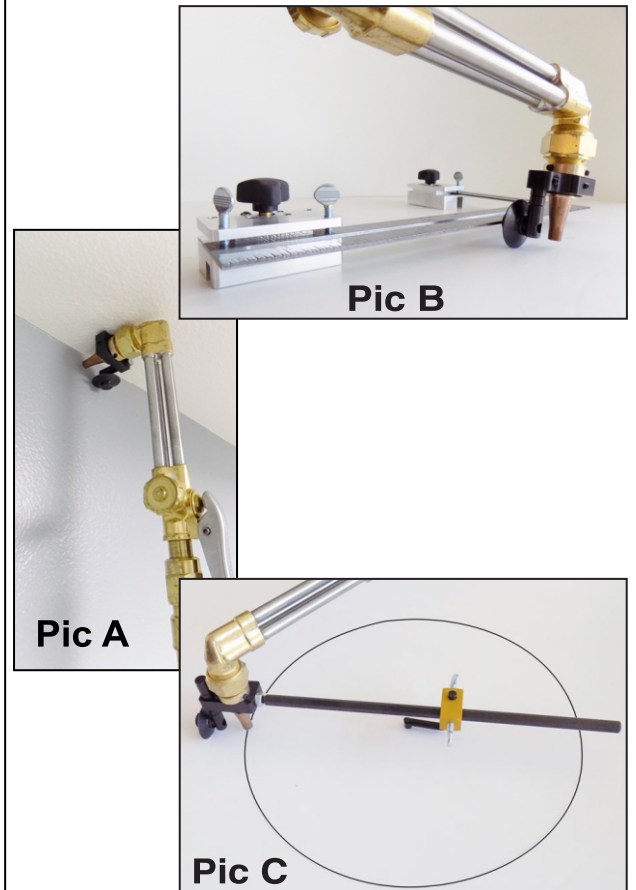

Circle Wiz

Item # CW-300

The Circle Wiz cutting attachment is a must for anyone who cuts small to medium holes in plate or pipe. It is especially handy for cutting out the holes for matching saddle cuts, weldolets and threadolets. Made of steel, the Circle Wiz has all the same qualities as other flange wizard® tools. The universal bushing will adapt to any size or make of conventional cutting torch. The Circle Wiz will cut holes from 5/8" in diameter to 8" in diameter. (Recommend **Chariot Beveling Guide P/N 24219-CBG for larger circles**.) Simply slide the hardened center pin along the hex arm to attain the proper radius of hole desire. Place the sharpened point in your center mark and you are ready to cut.

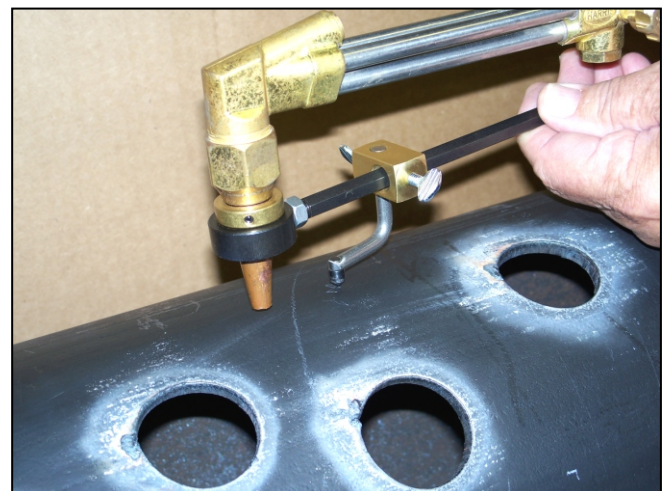
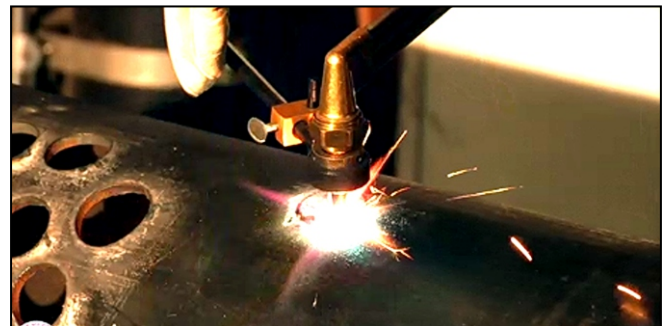

Short Video



Scan QR-Codes
to watch instructional Videos

CARE OF TOOL: Spray with WD40
or any light oil to protect from rust.

Detailed Video



Magnetic Circle Layout & Burning Guide

**Item #
28439**



Scan QR-Code
to watch
instructional
Video

WARNING:
Never use
the magnetic
base when
cutting holes
smaller than 8"
The heat will
damage the
magnets.

As a **circle layout tool** with sliding soapstone holder and 360° scale on the magnetic base. Will cut circles as small as 2" out of the base and up to 30" in diameter in the base. (recommend **Chariot Beveling Guide P/N 24219-CBG** for larger circles). Bolt circles, hole locations, baffle plate placement, and circle sectioning for any number of reasons is a snap with flange wizard®'s layout scale and sliding soapstone holder.

New upgraded feature
Cutting Guide Body with Wheel in front of tool
for better tool support and balance
and more cutting control.

As a **circle burning guide** use this same tool to cut a round plate, simply place the center punch mark and let the magnet slide down to sit firmly on the work surface. The magnet is strong enough to support the weight of your torch, which frees your hands for more cutting control.

CARE OF TOOL: Spray with WD40 or any light oil to protect from rust.

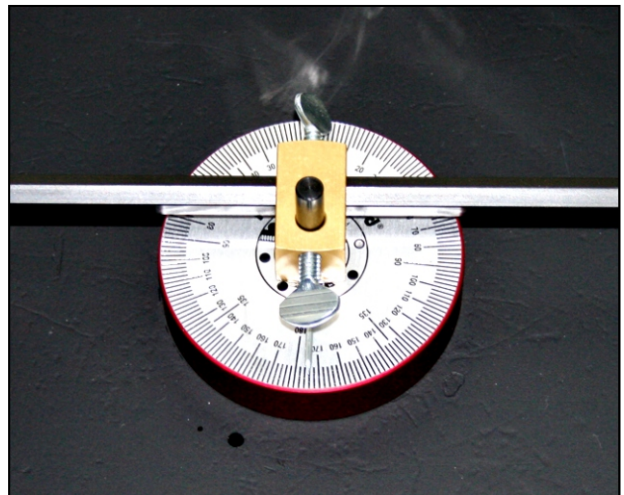
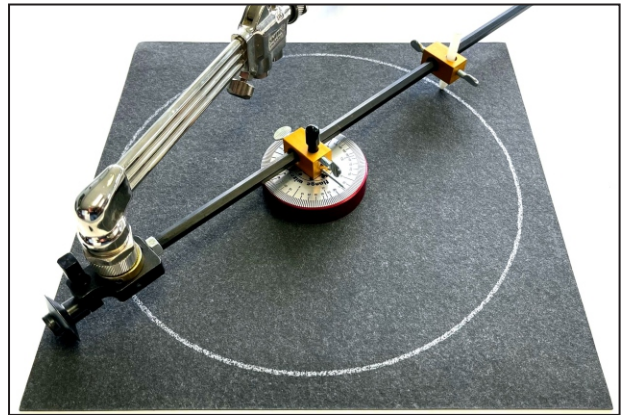

Torch-Tip Stand-off

Item # 70501

The Torch-Tip Stand-off is a must for anyone who uses a cutting torch and wants to keep their tip at the proper burning height at all times. Not only will this assist you in making more uniform cuts, but will keep your cutting tips from being damage and always ready for your next burning job. Simply slide the standoff over the cutting tip and against the bottom of the torch nut and tighten the set screw. Now you are ready to adjust the proper height by moving the sliding adjusting rod to a position that will keep the cutting tip at the desired distance from the work. You are ready to burn with confidence.

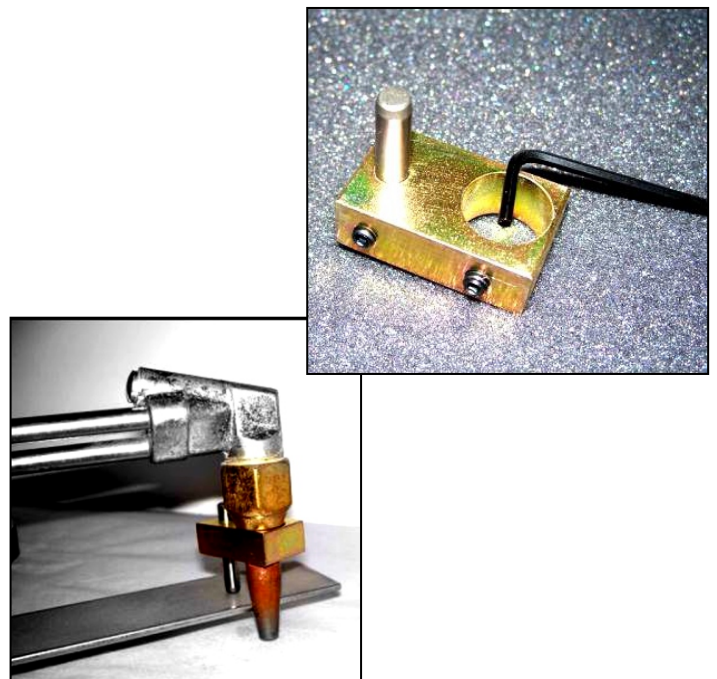

flange wizard® inc.

Plasma Beveling Cutting Guide w/Bushing (must specify size)

Item #
PBG-601-1.xxxx

Available accessories:
Magnetic Base w/Suction
Cups #77350

Extension Hex Bar 15-1/2" L
#3311-EX

Note: Bushing size to fit your plasma torch must be specified when purchasing your PBG-601 Plasma Beveling Guide

See the Plasma Bushing Chart on our website or page 19 of catalog.

See Picture of Bushing on page 19 of catalog

Scan QR-Codes to watch instructional Videos

Short Video



Detailed Video



CARE OF TOOL: Spray with WD40 or any light oil to protect from rust.

Flange Wizard's new burning guide is designed to not only cut straight, irregular shapes and circles, but also bevel them at the same time. The new improved design makes height adjustment and setting the head at the proper angle for beveling a simple job for the beginner as well as the journeyman.

The wheels can be adjusted for straight, irregular shapes, or circle cuts (Fig. A) and (Fig. B).

The new design allows you to use the third wheel (Fig. C) and (Fig. D) in conjunction with our **Magnetic Torch Guide model #MSG230** for precision burning or beveling edges of plate, beams and channels.

The head of the new guide will now lock in place for straight 90° or bevel cutting (Fig. E) at 22.5, 37.5 & 45 degrees.



Fig. C

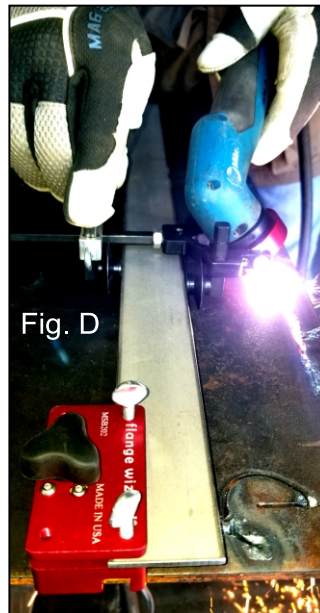

Fig. D



Fig. A

Cut 3-1/4" to 39" Dia. circles with regular set up (Fig. B).



Fig. B

Cut 7" to 37" Dia. circles when beveling inside (Fig. E).

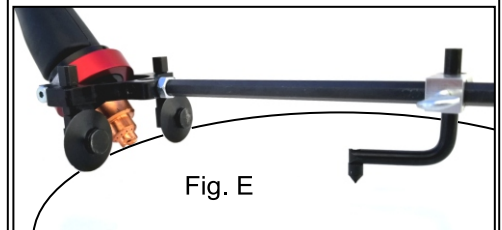
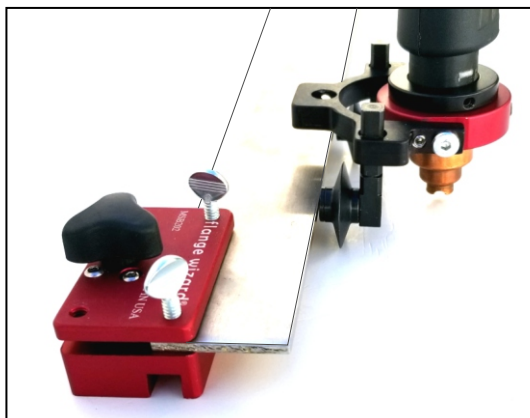

Fig. E

Cut 7" to 40" Dia. circles when beveling outside.



Plasma Wiz w/Bushing (must specify size)

Item #
30061-1.xxxx

Note: Bushing size to fit your plasma torch must be specified when purchasing your 30061 Plasma Wiz

See the Plasma Bushing Chart on our website or page 19 of catalog.

See Picture of Bushing on page 19 of catalog

Quality product designed to make your hole cutting jobs in steel and nonferrous metals a snap. Adjust the pivot pin for the proper height, move it along the hex bar to set the radius you want and lock it in place with the thumb screw. Put a center punch mark in your material where you want the hole to be, your pivot pin will not slip out.



Scan QR-Codes to watch instructional Videos



The Plasma Wiz will cut holes from 7/8" to 12" Dia. without any wheels.



Accessory Magnetic Base

Item #
77350

WARNING: Never use the magnetic base or suction cups when cutting holes smaller than 8". The heat will damage the magnets or suction cups.

This accessory for the Plasma Beveling Guide #PBG-601 serves as a third hand when cutting large holes. This base comes with a **straight pivot pin** and **suction cups** for use on non-ferrous metals.

Plasma Cutting Guide Not included.



Deluxe Combo Burning Guide Case

Item #
8920



24219-CBG



PBG-601-1.xxx

Case # 8900 (15.24"L x 12.32"W x 4.87" Deep) includes:

- 1 – Plasma Beveling Guide #PBG-601-11 (will cover straight and radius cuts along with hole burning from 3-1/4" to 39" diameter. **NOTE: Bushing size to fit your plasma torch must be specified when ordering.**
- 1 – Chariot Beveling Guide #24219-CBG (will cover straight & radius cuts along with hole burning from 2" to 36" diameter.
- 1 – Magnetic Base w/Straight Pin and Suction Cups #77350 (for larger holes and radiuses)
- 1 - Flange Wizard Tools Catalog

Scan QR-Codes to watch instructional Videos

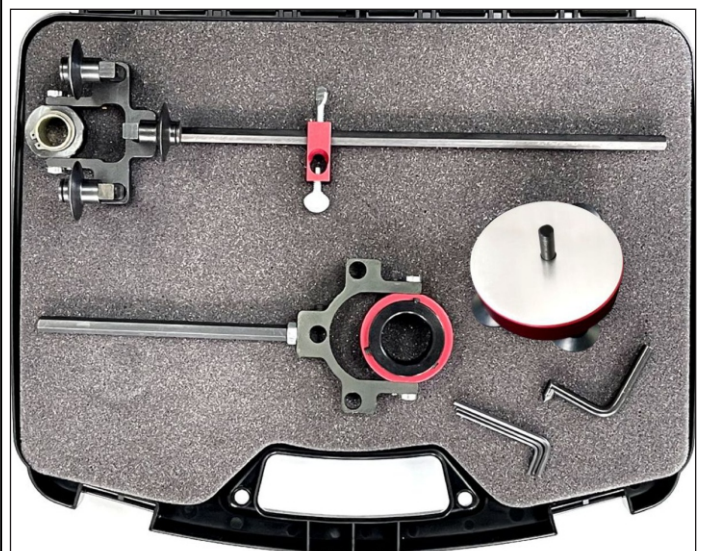

* See pages 14 & 17 for more detailed information *

flange wizard® inc.

Plasma Bushing for PBG-601 and 30061

ITEM #
61-1.xxxx

MUST SPECIFY
SIZE NEEDED

(See chart below
or on our Website)

The **Plasma Bushing** is made of quality aluminum and anodized for protection and longevity. It comes in two (2) standard sizes, each with one **Sleeve** based on the head diameter of the torch you are using. It has three set screws to adjust to torch heat shield.



Plasma Bushings for Plasma Wiz (P/N 30061) & Plasma Beveling Guide (PBG-601, PG-602 & PG-604)

BUSHING Outside Dia. 1-3/8"	TORCH BRAND AND MODEL NUMBER	HEAD Diameter of torch	Bushing I.D. and FWI Part Number	WILL FIT FWI P/N's
Hypertherm	Air T30; Duramax; Duramax HRT/HRTs; Duramax HRT2; Duramax LT; Duramax MRT; Duramax RT; PAC105; PAC110; PAC120; PAC121; PAC123; PAC125; PAC140; RT60; RT80; T100; T30V; T45V; T60; T80 PAC130; PAC160	.750 to 1.070	61-1.070	PBG-601 (Plasma Beveling Guide) & 30061 (Plasma Wiz)
Miller	ICE 25 C/CX, 27 C/T, ICE-27 ICE-40C, ICE 40T, ICE-50C, ICE-55C, ICE-60T, ICE-80T, Spectrum 875	(3/4" to (1-1/16"))	*Comes with a 1.007 Sleeve for optimum tolerance	
Thermadyne	SL-40			
ESAB	250, 380, 650, Cutmaster 42 SL40 Torch			
Hypertherm	PAC135 Power Max 1100, PAC 135, Smart Tip/Sync	1.070 to 1.275	61-1.275	PBG-601 (Plasma Beveling Guide) & 30061 (Plasma Wiz)
Miller	Spectrum 500, 750, XT-30C, XT-40, 375X	(1-1/16" to 1-17/64")	*Comes with a 1.200 Sleeve for optimum tolerance	
Thermadyne	SL-60, SL-100, RPT-100 (New #1), Drag-Gun, Cutmaster 50, 52, 100, 102, PCH 42			
Lincoln	LC-25, LC-40 Lincoln 125, PGT 125 Torch			
ESAB	900, 1300, 1600, PT-27 or I-750, I-1000, Cutmaster 58 & 60			

Special Order

Hypertherm	Duramax-Hyamp	1.350 to 1.375	64-1.380	Ask for PG-604
BUSHING O.D. 1-1/2"				
Thermadyne	PCH-120 Torch (Special)	1.400 to 1.425	62-1.430	Ask for PG-602
BUSHING O.D. 1-7/8"	Larger head diameter on heat shield - call for quote			

flange wizard® inc.

Magnetic Torch Guide and 24" Extension/ With New ON/OFF Magnet

Item #'s
MSG230
MSG230-24

"New ON/OFF Magnet"

- The basic model #MSG230 is the 24" cutting rail with two (2) adjustable magnetic holding blocks.
- The 24" Extension #MSG230-24 comes with the 24" cutting rail and one (1) adjustable magnetic holding block

Block size:
1" x 1-1/2" W x 2-1/2" L

Rail size:
1/8" x 1-1/2" W x 24" L

Will accommodate a
3/16" thick rail

3/4" from top of blade
to cutting surface.

Warning: Excessive heat can damage the magnets. Keep magnet block away from sensitive electronic devices. Keep magnet block in "OFF" position when not in use.



Scan QR-Code to watch
instructional Video

For steadier cutting, the improved Magnetic Torch Guide has 60 lb. pull ON-OFF magnets for ease of setup and release of debris. The two magnetic blocks can be positioned any place along the 24" stainless steel cutting rail to accommodate any cutting job. The magnetic blocks are slotted on three (3) sides and are tightened with 10-24 thumb screws allowing a variety of configurations on the cutting rail. 24" extensions available that allow you to add all the length you need for those special cutting jobs. The cutting guide is stainless steel and works with conventional or plasma torches.

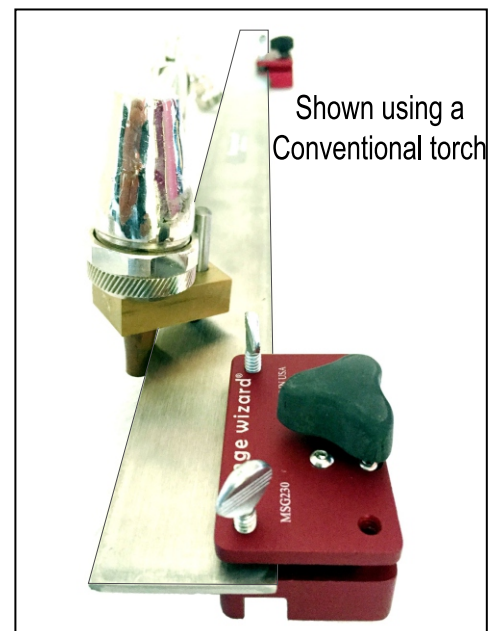
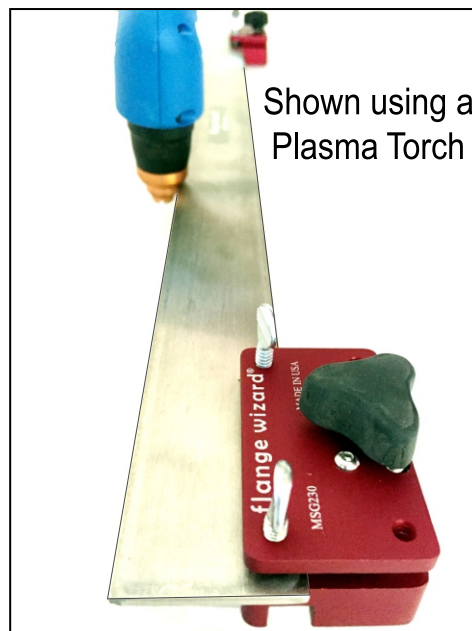
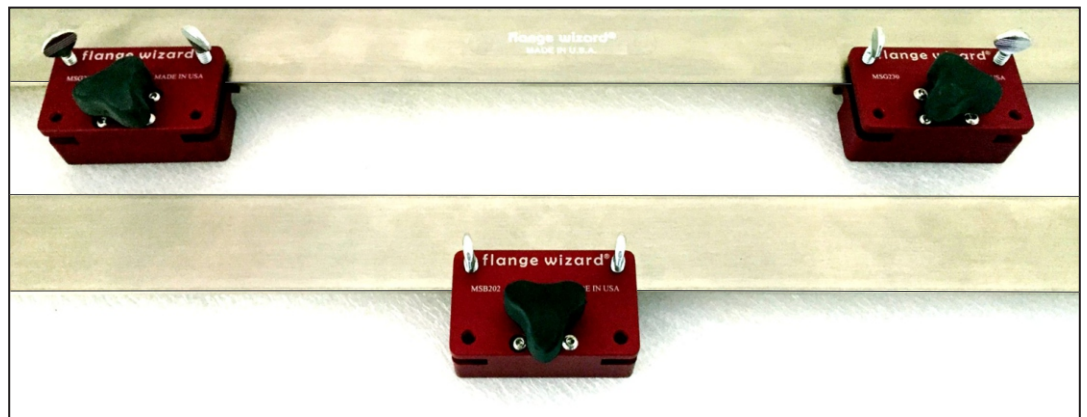

flange wizard® inc.

Magnetic Blocks (2 to a set)/ With New ON/OFF Magnet

Item # MSB202

* Individual blocks available
Item # MSB201

Warning: Excessive heat can damage the magnets. Keep magnet block away from sensitive electronic devices. Keep magnet block in "OFF" position when not in use.



Scan QR-Code to watch instructional Video

These 60 lb. magnetic support blocks can be attached to any standard square or straight edge up to 3/16" thick to form your own burning guide. The blocks are slotted on (3) sides and are tightened with 10-24 thumb screws making the tool much more versatile than ever before.

The ON/OFF switch makes setting up easy and keeps the blocks free from debris.

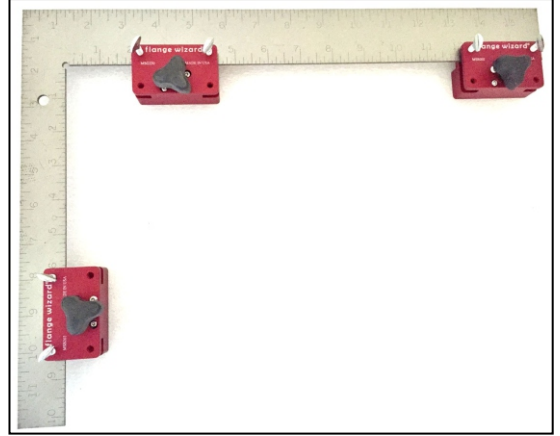

Make your own flange square.

Multi-Use Angle Burning Guide/ With New ON/OFF Magnet

Item # ABG750

Warning: Excessive heat can damage the magnets. Keep magnet block away from sensitive electronic devices. Keep magnet block in "OFF" position when not in use.

Stainless Steel Rail size:
1/8" x 1-1/2" W x 16" L

This tool features a 90 lb. pull ON/OFF magnet for a superior hold either horizontal or vertical (Fig. A & D).

This new technology is a must for every tradesman who uses a conventional or plasma torch and wants an excellent angle or straight cut every time. It can also be used as a protractor (Fig. B) or as a multi-angle tri-square (Fig. C). The Angle Burning Guide will hold any standard square as well as most straight edges up to 3/16" thick (Fig. D). Special squaring and marking jobs are a snap with your new multi-use tool.

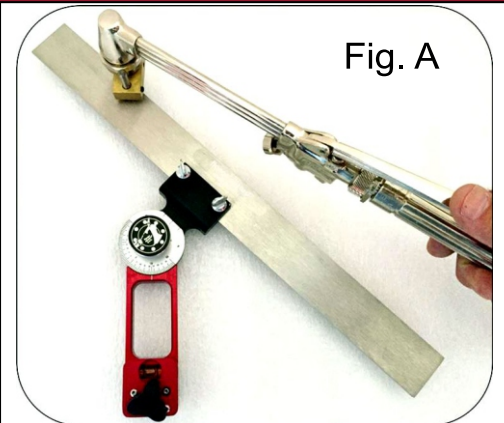

Fig. A

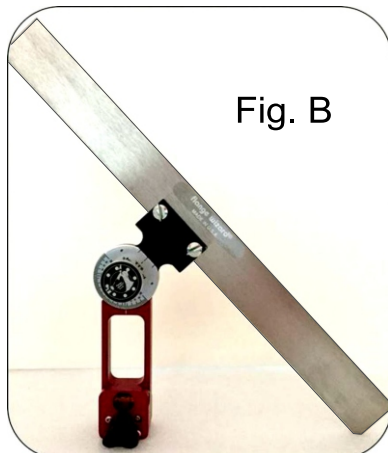

Fig. B

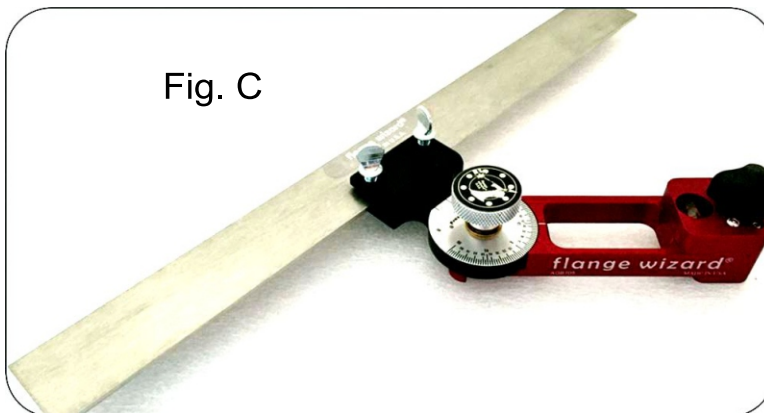

Fig. C



Fig. D

Wizard Pipe Wraps (pipe wrap-arounds)

Item #'s

WW-16

-Small 1" to 6" pipe
(30" L x 2-5/8" W)

WW-17

-Medium 2" to 16" pipe
(60" L x 3-7/8" W)

WW-17A

-Large 6" to 30" pipe
(120" L x 5-1/4" W)

WW-19

-Ex-large 12" to 48" pipe
(180" L x 7" W)

CUSTOM WRAPS

Special order lengths
(sold by the foot) and
widths are available:

WW-18

- 5-1/4" wide x any length

WW-18A

- 7" wide x any length

NOTE:

Custom Wraps
are not screened,
and are sold
by the linear foot.

Special order
length formula:
 $L = 5 \times \text{diameter}$



Scan QR-Code
to watch instructional Video

Wizard Pipe Wrap is made from a non-asbestos, heat resistant material. Edges are sanded and straight for easier more accurate marking.

Exclusive features include:

- 28" tape measure on the **small Wizard Pipe Wrap.**
- 36" tape measure printed on the **medium & large Wizard Pipe Wraps.**
- 48" tape measure printed on the **Extra Large Wizard Pipe Wrap.**

This limits the need for an extra tape measure, and makes mark-up easier.

- "Circumference & Quartering" scale printed on every small, medium and large Wizard Pipe Wrap.

This limits the need for calculations because the exact circumference, 1/4, 1/2 and 3/4 of the circumference, plus the actual pipe diameter for 2" through 30" pipe is printed on the outside of the Wizard Pipe Wrap.

- Packaged in a durable, reusable container that will hold up in your toolbox.
- Oil, gasoline, kerosene, water and sea water resistant.

* **New one degree decimal equivalent scales on all wraps.**
(Fig. A)

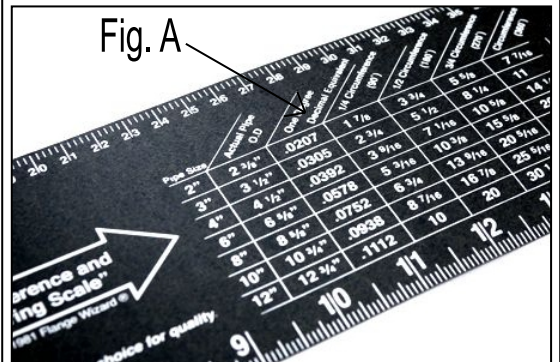
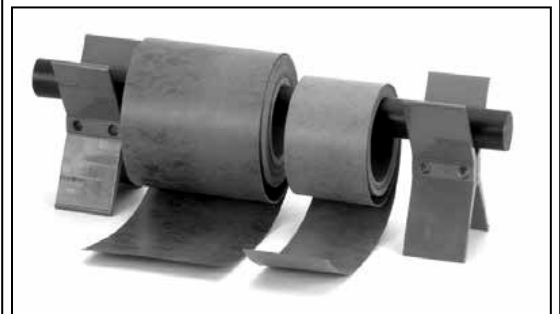
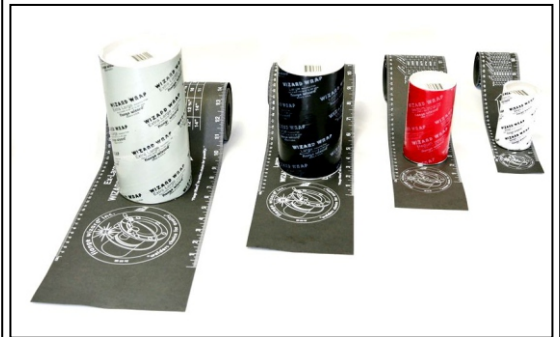

Miter Marker & Imager Combo

Item #
MMC505



Combo Case

Two Complete Tools in One Case

Miter Marker Arm Assembly #MSA505
(size range 1-1/2" to 18" pipe & 18" structural beams)

AND

Multi-Hole Imager Tower Assembly #MHA515
(for elongated holes in plate or ellipse holes in pipe
at any angle up to 18" in diameter)

Both With 150 lb. Pull OFF/ON Magnetic Body
flange wizard®'s pipe layout tools are now designed using
the newest OFF/ON magnetic technology. **Replace multiple
templates just with one tool.** (Carrying Case # 8900)

* A **Spring Buckle Strap #5010** is available to hold base
tight on **non-magnetic** work materials.

Scan QR-Code
to watch Video



*Instruction
Guides
Included



Master Maker & Imager Combo

Item #
MMC510



Combo Case

Two Complete Tools in One Case

Master Marker Arm Assembly #MLA510
(size range 8" to 48" pipe & 48" structural beams)

AND

Multi-Hole Imager Tower Assembly #MHA515
(for elongated holes in plate or ellipse holes in pipe
at any angle up to 18" in diameter)

Both With 150 lb. Pull OFF/ON Magnetic Body
flange wizard®'s pipe layout tools are now designed using
the newest OFF/ON magnetic technology. **Replace multiple
templates just with one tool.** (Carrying Case # 8900)

* A **Spring Buckle Strap #5010** is available to hold base
tight on **non-magnetic** work materials.

Scan QR-Code
to watch Video



*Instruction
Guides
Included



flange wizard® inc.

Pipe Magician Case

**Item #
8905**



Scan QR-Code
to watch
instructional Video

A person who works with pipe needs the finest tools available and a way to protect them when not in use. The four (4) quality tools in this case are a must when working with pipe.

Case #8900 (15.24" Long X 12.32 Wide X 4.87" Deep) includes:

- 1 - **Pipe Flange Aligner # 38240-T**,
- 1 - **Medium Magnetic Centering Head # 53076-M**
- 1 - **Pocket Pro Level # PP-200**
- 1 - **Small Wizard Pipe Wrap # WW-16**
- 1 - Flange Wizard Tools Catalog
- 1 - **FREE BONUS Vial Repair Kit # 5102**



Wizard Burning Guides

**Item #
8910**

Scan QR-Code
to watch
instructional Video



*See page 14
for more Chariot
Beveling information*

Case # 8900 (15.24" Long X 12.32" Wide X 4.87" Deep) includes:

- 1 - **Chariot Beveling Guide #24219-CBG-11** (will cover straight and radius cuts along with hole burning from 2" to 25" diameter.
- 1 - **Magnetic Degree Base (3100) w/Straight Pin (3511) and 5/8" Square Point Pin Holder (3411)** (for larger holes and radiuses)
- 2 - **Magnetic Blocks #MSB202** (great for clamping on squares and straight edges)
- 1 - **Magnetic Tape Holder #89754** (third hand when working alone)
- 1 - Flange Wizard Tools Catalog
- 1 - **FREE BONUS Torch Tip Standoff #70501** (protects torch tip end by controlling the distance from the material)



Lil' Wiz Case

**Item #
8915**

Scan QR-Code
to watch
instructional Video



This is a great kit for anyone who burns holes (5/8" to 10" dia.) in pipe, plate or structural steel

Case #8901 (10-1/4"L x 8"W x 3" Deep) includes:

- 1 - **Circle Wiz # CW-300**
- 1 - **Combo Degree Level #L-2** (pocket size, magnetic, with 2-1/2° increments)
- 1 - **Small Magnetic Centering Head #53025-M** (marks any degree needed around circumference of a bar or pipe)
- 1 - **Magnetic Tape Holder # 89754** (third hand when working alone)
- 1 - Flange Wizard Tools Catalog
- 1 - **FREE BONUS Vial Repair Kit #5102**



flange wizard® inc.

Pipe Magician Case

**Item #
8905-M**



Scan QR-Code
to watch
instructional Video

A person who works with pipe needs the finest tools available and a way to protect them when not in use. The four (4) quality tools in this case are a must when working with pipe.

Case #8900 (15.24" Long X 12.32" Wide X 4.87" Deep) includes:

- 1 - **Magnetic Pipe Flange Aligner** # 38240-MAK
- 1 - **Medium Magnetic Centering Head** # 53076-M
- 1 - **Pocket Pro Level** # PP-200
- 1 - **Small Wizard Pipe Wrap** # WW-16
- 1 - Flange Wizard Tools Catalog
- 1 - **FREE BONUS**
Vial Repair Kit # 5102



Wizard Plasma Burning Guides

**Item #
8910-P**

Scan QR-Code
to watch
instructional Video



*See page 17
for more Plasma
Beveling information*

Case # 8900 (15.24" Long X 12.32" Wide X 4.87" Deep) includes:

- 1 - **Plasma Beveling Guide** #PBG-601-11 (will cover straight and radius cuts along with hole burning from 3-1/4" to 25" diameter.
- 1 - **Magnetic Base w/Straight Pin and Suction Cups** #77350 (for larger holes and radiuses)
- 2 - **Magnetic Blocks** #MSB202 (great for clamping on squares and straight edges)
- 1 - **Magnetic Tape Holder** #89754 (third hand when working alone)
- 1 - Flange Wizard Tools Catalog

NOTE: Bushing size to fit your plasma torch must be specified when ordering.



Lil' Wiz Plasma Case

**Item #
8915-P**

Scan QR-Code
to watch
instructional Video



This is a great kit for anyone who burns holes (5/8" to 10" dia.) in pipe, plate or structural steel.

Case #8901 (10-1/4"L x 8"W x 3" Deep) includes:

- 1 - **Plasma Wiz** # 30061-1.xxxx
- 1 - **Combo Degree Level** #L-2 (pocket size, magnetic, with 2-1/2° increments)
- 1 - **Small Magnetic Centering Head** #53025-M (marks any degree needed around circumference of a bar or pipe)
- 1 - **Magnetic Tape Holder** # 89754 (third hand when working alone)
- 1 - Flange Wizard Tools Catalog
- 1 - **FREE BONUS** Vial Repair Kit #5102

NOTE: Bushing size to fit your plasma torch must be specified when ordering.



Scan QR-Code to watch instructional Video

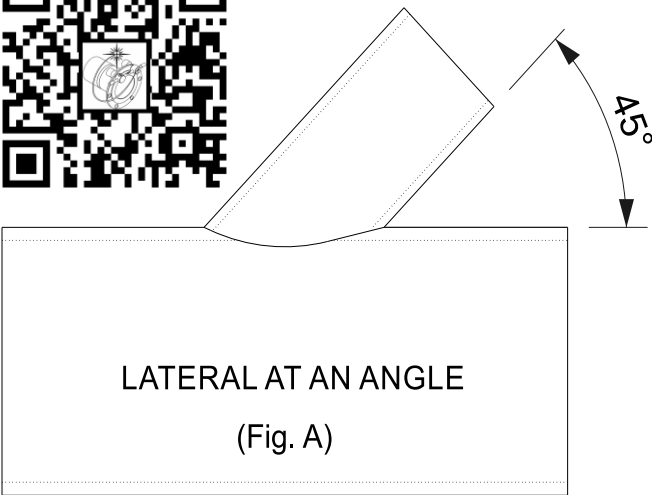

To layout a Lateral at an angle (Fig. A),

Set the Miter Marker to the angle of the lateral and mark a line around the pipe as shown in step 1. At a right angle to this line, scribe a line equal to 1-1/2 times the saddle depth. This point must be on the pipe centerline as shown in step 2. Mark the lines A-C and B-C. Lay off the saddle depth and round off the point as shown in step 3.

To mark the opening in the larger pipe use our Multi-Hole Imager P/N MH1515

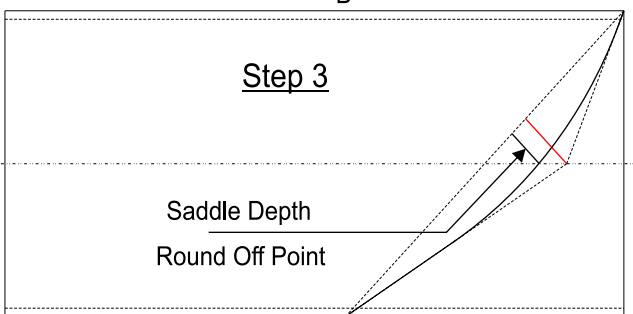
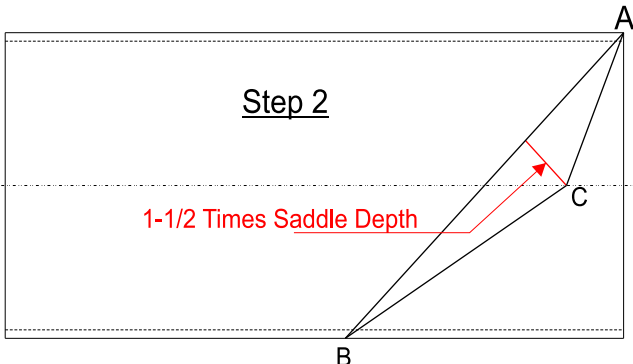
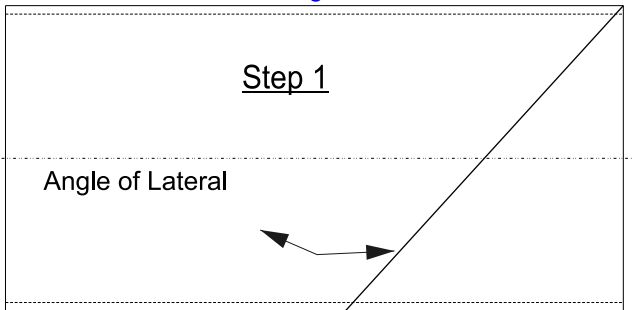

LATERAL PIPE SIZE (Small Pipe)

	2-3/8	3-1/2	4-1/2	6-5/8	8-5/8	10-3/4	12-3/4	14	16	18	20	24
2-3/8	45° 1-3/16 3/8											
3-1/2	35° 3/4	45° 1-3/4										
4-1/2	30° 9/16	35° 7/16	45° 3/4									
6-5/8	20° 3/8	30° 1/4	30° 7/16	45° 1-1/8								
8-5/8	15° 5/16	20° 9/16	25° 15/16	35° 2-3/8	45° 4-5/16							
10-3/4	10° 1/4	15° 15/32	20° 3/4	28° 1-3/4	38° 3-5/16	45° 5-3/8						
12-3/4	5° 3/16	10° 1/8	15° 1/4	25° 1/2	30° 7/8	40° 1-1/2	45° 2-1/8					
14		10° 3/8	10° 9/16	22° 1-5/16	28° 2-1/4	35° 3-3/4	42° 6-3/16	45° 7				
16			10° 1/2	20° 1-1/8	22.5° 1-7/8	30° 3-1/16	35° 4-13/16	40° 6-3/16	45° 8			
18			10° 3/16	17° 3/8	22° 5/8	27.5° 1	30° 1-5/8	35° 2-1/16	42.5° 2-11/16	45° 2-11/16		
20			8° 3/8	13° 7/8	18° 1-1/2	25° 2-3/8	30° 3-1/2	38° 4-5/16	42.5° 6	45° 8-7/16	10	
24			8° 1/8	12° 5/16	15° 1/2	20° 15/16	22.5° 1-3/16	25° 1-7/16	30° 2	30° 2-13/16	40° 3-3/8	45° 4

flange wizard®
Pipe Saddle Chart
Reg. No 1, 015, 681



(Note: All figures rounded to the nearest 1/32")

- Wizard Arm Degree
- Saddle Depth x 1.5
- Tip Round Off

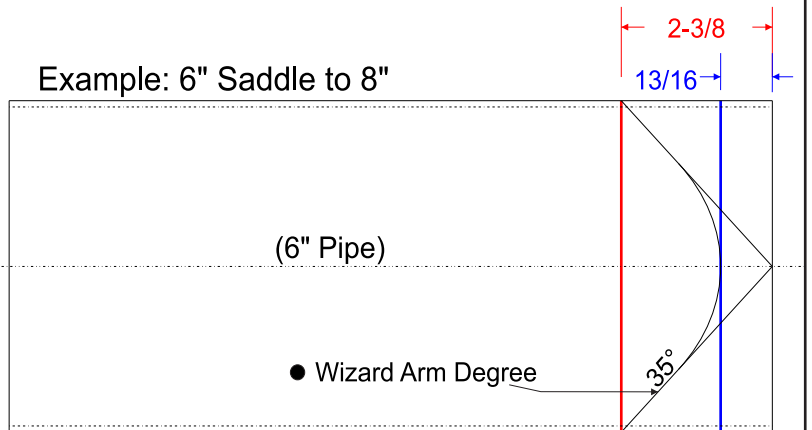

Example shown:

2-3/8" - 13/16" = 1-9/16" Actual Saddle Depth

PRODUCT WARRANTY TO END USERS

Flange Wizard® Inc. stands behind the manufacturing quality of all its tools. All products are warranted for one (1) year from date of purchase by end user. Coverage includes manufacturing workmanship and normal use of tool within the scope of tool's design.

***Instructional Videos available online**

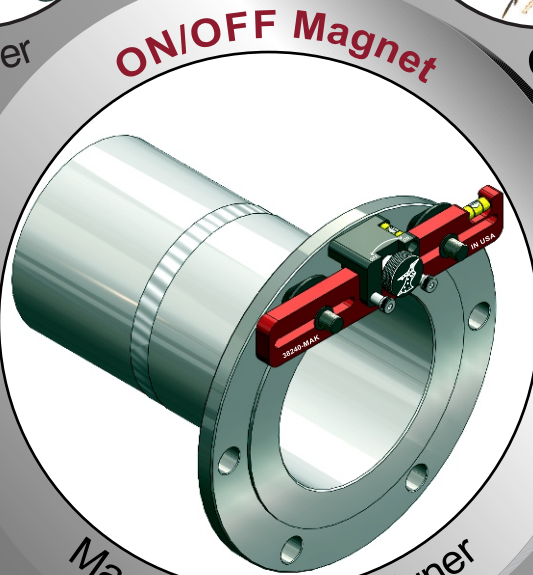
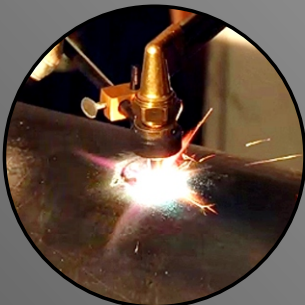
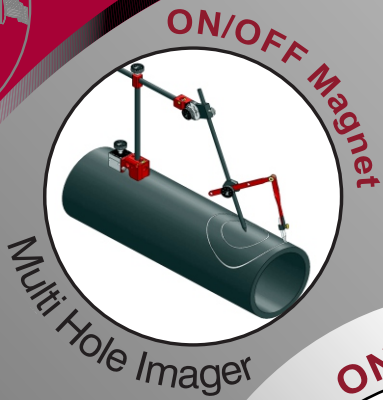

flange wizard® inc.

1950 Estelle Lane, Placentia, CA 92870

(714) 792-1949 * FAX (714) 961-0949

www.flangewizard.com

MADE IN THE U.S.A.

Manufacturers of:

- Pipe Flange Aligners (3 models)
- Two Hole Pins (7 models)
- Radius Markers (3 models)
- Circle Cutting Guides (7 models)
- Pocket Pro Level • Standard Pocket Level
- Magnetic Torch Guides
- Wizard Wrap Arouds (4 models)
- Centering Head Tools (5 models)
- Master Marker
- Miter Marker • Multi-Hole Imager
- Plasma Burning Guides (3 models)